

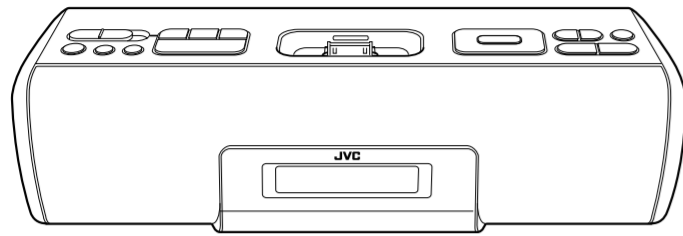

PORTABLE AUDIO SYSTEM

RA-P50W/RA-P51B



Specifications

| | | |
|----------------------------|-------------------------------------------|-----------------------------------------------------------------------|
| Model | RA-P50W/RA-P51B | |
| Type | Portable audio system | |
| Amplifier | Power Output | 4 W x 2 1 kHz 10 % THD, 6 Ω |
| | Input Sensitivity/ Impedance | AUDIO IN 250 mV/47 kΩ |
| Tuner | Band | FM |
| | Tuning Range | 87.50 MHz - 108.00 MHz * The tuning step width may vary by region. |
| | Frequency Step | 50 or 100 kHz |
| | Preset Stations | 20 |
| Speaker | 1way full range, diameter 50 mm x 2 | |
| Input Terminal | External DC IN (for AC adapter) | |
| | AUDIO IN (mini jack) | |
| iPod connector | Output Power : DC 5 V | 500 mA |
| | DC 9 V | 1.5 A (EXTERNAL DC IN) |
| | DC 3 V | (CR2025, for the clock) |
| Power Source | DC 9 V | (SIZE R6, AA BATTERY OR EQUIVALENT x 6) |
| | DC 3 V | (CR2025, for the clock) |
| Power Consumption | 0.5 W (in Standby mode) | |
| | 13 W (Power On mode) | |
| AC adapter | Input : AC 110-240 V $\sqrt{}$, 50/60 Hz | 0.5A |
| | Output : DC 9 V | 1.5 A |
| Dimensions (W x H x D) | (W) 310 mm x (H) 88 mm x (D) 93 mm | |
| Weight (Without batteries) | 0.8 kg | |
| Accessory | See Supplied Accessories | |

Specifications and appearance are subject to change without prior notice.

1. Getting Started

● Supplied Accessories

After unpacking, check to be sure that you have all the following items.

- AC adapter AA-R9029 (For RA-P50W) or, AA-R9032 (For RA-P51B)
Australia : AA-R9037 (For RA-P50W) or, AA-R9038 (For RA-P51B)
- CR2025 lithium coin battery (Loaded on the back panel of the Unit at the factory.)

Warning

- Store the battery in a place where children cannot reach. If a child accidentally swallows the battery, consult a doctor immediately.
- Do not recharge, short, disassemble or heat the battery or dispose of it in a fire. Doing any of these things may cause the battery to give off heat, crack, or start a fire.
- Do not leave the battery with other metallic materials. Doing this may cause the battery to give off heat, crack, or start a fire.
- When throwing away or saving the battery, wrap it in tape and insulate; otherwise, the battery may start to give off heat, crack, or start a fire.
- Do not poke the battery with tweezers or similar tools. Doing this may cause the battery to give off heat, crack, or start a fire.
- Dispose of battery in the proper manner, according to federal, state, and local regulations.

CAUTION:
Danger of explosion if battery is incorrectly replaced.
Replace only with the same or equivalent type.

● Preparation of the Unit

- ◆ Turn the Unit over to the back side and remove the insulation sheet before using for the first time.
→ The display of the Unit lights up and shows the default clock.

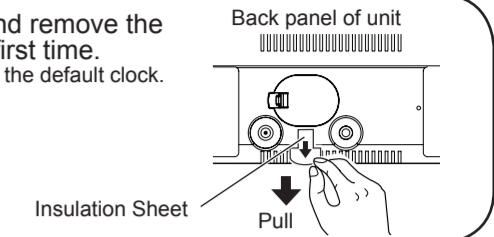

- ◆ Loading batteries for the Unit (The battery power supply)
Insert three batteries to each compartment (six batteries total). Be sure to match the poles (+/-) correctly. While the AC adapter is connected to the wall outlet, the unit works without batteries.

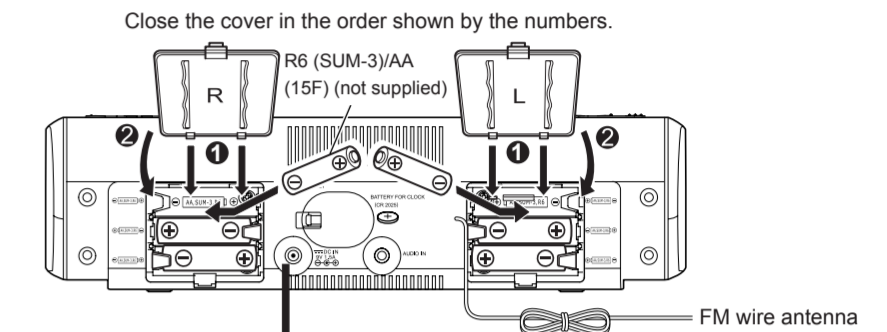

◆ Connecting the AC adapter

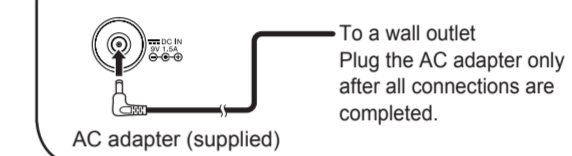

CAUTION:
To avoid risk of fire, and to prevent damage.
• Do not use AC adapters except for the supplied AC adapter.
• Do not use the supplied AC adapter for other equipment.

INSTRUCTIONS

EN

LVT2019-013A [UJ,US,UW,A]
©2009 Victor Company of Japan, Limited 0709KMMCREBET

Warnings, Cautions and Others / Mises en garde, précautions et indications diverses

Thank you for purchasing a JVC product. Please read all instructions carefully before operation, to ensure your complete understanding and to obtain the best possible performance from the unit.

CAUTION
To reduce the risk of electrical shocks, fire, etc.:
1. Do not remove screws, covers or cabinet.
2. Do not expose this appliance to rain or moisture.

CAUTION
• Do not block the ventilation openings or holes. (If the ventilation openings or holes are blocked by a newspaper or cloth, etc., the heat may not be able to get out.)
• Do not place any naked flame sources, such as lighted candles, on the apparatus.
• When discarding batteries, environmental problems must be considered and local rules or laws governing the disposal of these batteries must be followed strictly.
• Do not expose this apparatus to rain, moisture, dripping or splashing and that no objects filled with liquids, such as vases, shall be placed on the apparatus.

CAUTION
The ϕ /I button in any position does not disconnect the mains line.
Disconnect the mains plug to shut the power off completely.
The MAINS plug or an appliance coupler is used as the disconnect device, the disconnect device shall remain readily operable.
To be completely disconnect the power input, the AC/DC adaptor of apparatus shall be disconnected from the mains.
The AC/DC adaptor of apparatus should not be obstructed OR should be easily accessed during intended use.

Caution: Proper Ventilation
To avoid risk of electric shock and fire, and to prevent damage, locate the apparatus as follows:
1. Front: No obstructions and open spacing.
2. Sides/ Top/ Back: No obstructions should be placed in the areas shown by the dimensions below.
3. Bottom: Place on the level surface. Maintain an adequate air path for ventilation by placing on a stand with a height of 10 cm or more.

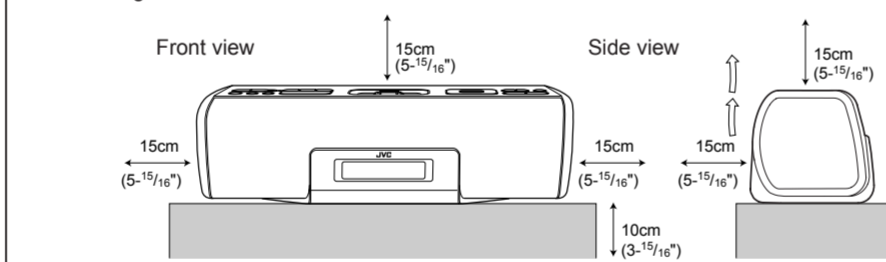

CAUTION
Battery shall not be exposed to excessive heat such as sunshine, fire or the like.



[European Union only]

2. Basic and Common Operations

| | | | | | |
|-------|-----------------------------------------------------------------------------------------------------------------------------------------------------------------------------------------------------------------------------------------------------|-------|---------------------------------------------------------------------|-------|-----------------------------------------|
| Press | Functions | Press | Functions | Press | Functions |
| | • Light the display screen for 5 seconds when the power is turned off. • Temporarily stop the alarm sound when the alarm is ringing (SNOOZE). (see "Stopping the alarm sound P4") • Switch on/off the backlight when the button is held down. | | • Switch FM stereo/monaural when FM is selected. See P3. (see P3-4) | | Select a source iPod → FM → AUDIO IN |

| | | | | | |
|-------|--------------------------------------------------------------------------------------------------------------------------------------------------------------------------------------------------|-------|-----------------------------------------------------|-------|-----------------------------------------------------------------------|
| Press | Functions | Press | Functions | Press | Functions |
| | Turns on or off (standby) the power When the unit enters the standby mode at volume level "15" or higher, the unit automatically sets the volume level to "14" the next time it is turned on. | | Select a preset. | | Turn off the sound. Return to the original mode by pressing again. |
| | Set the Sleep Timer. See P4. | | Adjust the volume level from 00 to a maximum of 20. | | |

| | |
|-------|-------------------------------------------------------------------------------------------------------------------------------------------------------------------------------------------------------------------------------------------------|
| Press | Functions |
| | • Switch on/off the SURROUND. You can enjoy music with spatial and deep sound in this mode. (The mode is not effective when the monaural is selected.) • While the clock or the alarm time are set, return to the previous item. See P3-4 |

● Display Information

| | | | | |
|------|------------------------------------|--------------------------|-----------------------------------------------------------------------|---------------------------------------------------------|
| Date | ALARM1 MONTH DATE ALARM2 18/88 | iPod AUDIO IN FM ST MONO | When adjusting the volume | 00 - 20 |
| | z ^z SLEEP | AM 10:00 | When FM radio is selected | P01 - P20 (channel) / 87.50 - 108.00 MHz (frequency) |
| | Mon Tue Wed Thu Fri Sat Sun DAY | PM 10:00 SUR | When the source is set to iPod and the alarm is set to TIMER PLAY | iPod (blinking) |
| | Day of the week | MHz | When the source is set to FM radio and the alarm is set to TIMER PLAY | FM (blinking) |
| | | | When battery power is low | --- |
| | | | When trying to set alarm to TIMER PLAY while selecting AUDIO IN | Err |

◆ Explanation of Icons

ALARM 1 Off: current time / On: alarm time

ALARM 2 Off: alarm off / On: alarm on / Blinking: alarm sounding (When "TIMER PLAY" is set)

z^z Blinks while snoozing (the alarm is paused)

SLEEP Lighting when the sleep mode is selected.

SUR SURROUND starts lighting when it is switched on.

ST MONO "ST" is displayed when an FM stereo broadcast is received.
"MONO" is displayed when the monaural is selected. (see "Listening to FM Broadcasts")

• Current time: Blinking / Other Clock Display: Lighting

🔇 🔇 is displayed when the sound is muted.

3. How to set the time

Setting the Clock

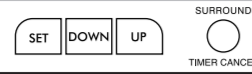

- The time can be set both when the power is on and off.
- 1 Press and hold the SET button. → The year display starts flashing.
- 2 While flashing, set each item with the DOWN/UP buttons.

- 3 Press the SET button.
- When the SET button is pressed, the flashing items will change in the following order.

Year → Month → Day → 12/24-hour time → Hour → Min. → time display

The time is set when switching to time display from Minutes.

NOTES

- To modify the setting, start again from step 1.
- To return to the previous item, press the TIMER CANCEL button.

4. Playing back from iPod

Setting the iPod on the unit

- 1 Insert the Dock adapter supplied with the iPod to the unit.
- If the Dock adapter was not supplied with your iPod, purchase the Dock adapter from Apple Inc. For details, visit the Apple's website. <http://www.apple.com>

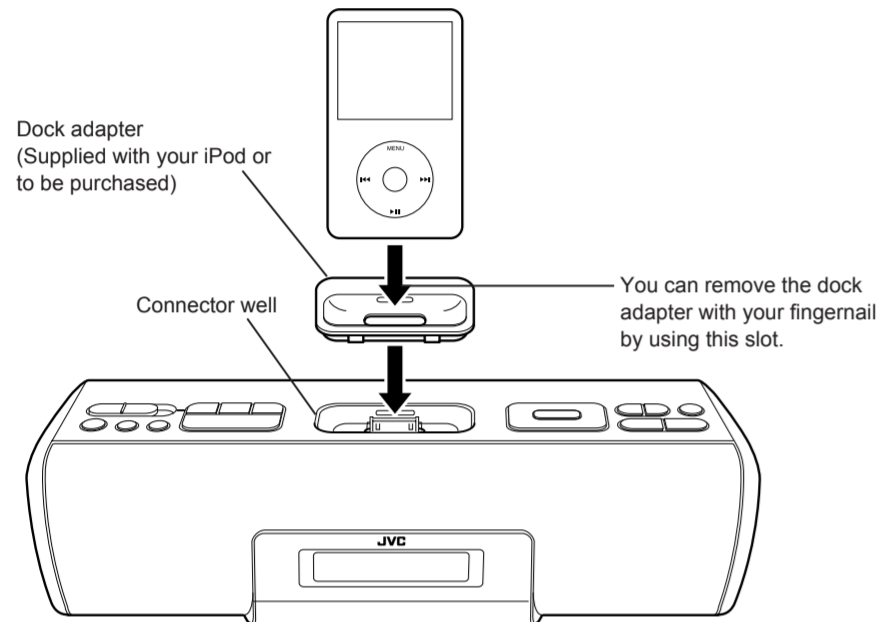

- 2 Connect the iPod to the connector plug of the unit.
- The connector plug is protected with a cover when it is first purchased. Please remove the cover before operating the unit.
- When the iPod is not connected, insert the terminal cover. This prevents dust from entering and possibly damaging the unit.
- Always set volume to the minimum level when connecting or disconnecting iPod.
- When you connect your iPod to the unit, make sure you insert it all the way.
- When disconnecting the iPod, make sure that the System is turned off.

iPod Compatibility Chart

| | |
|-------------------------------------------------|----------------------------------------|
| iPod touch 8GB/16GB/32GB | iPod nano (3rd Generation) 4GB/8GB |
| iPod touch (2nd Generation) 8GB/16GB/32GB | iPod nano (4th Generation) 8GB/16GB |
| iPhone 3G 4GB/8GB/16GB | iPod nano (2nd Generation) 2GB/4GB/8GB |
| iPhone 4GB/8GB/16GB | iPod nano 1GB/2GB/4GB |
| iPod classic 80GB/120GB/160GB | iPod (4th Generation) 20GB/40GB |
| iPod video (5th Generation) 30GB/60GB/80GB | iPod mini (2nd Generation) 4GB/6GB |
| iPod photo (4th Generation) 20GB/30GB/40GB/60GB | iPod mini 4GB/6GB |

Listening to the iPod

- 1 Connect the iPod to the unit.
- Turn the unit power on.
- Select "iPod" with the SOURCE button.
- When iPod is selected as sound source, it automatically starts playback.

| Press | Functions |
|-------|------------------------------------------------------------------------------------------------------------------------------|
| ▶ | Playback/Pause Press and hold this button to switch the iPod to sleep mode. |
| ▶▶ | Next song / fast forward (press and hold) |
| ◀◀ | Previous song (Press this button during playback to jump back to the beginning of the track.) / fast rewind (press and hold) |

Charging the iPod

- The iPod is charged while it is set on the unit when the Unit power is on.
- Connect the AC adapter to the Unit. The iPod battery is not charged while the Unit is operated on the battery power supply.
- The iPod is charged regardless of the sound source selected on the Unit.
- See the iPod instruction manual about charging times.

NOTES

- This unit can only play the iPod audio.
- You can use the iPod video function and hear the audio but cannot play the video.
- Do not carry the System with iPod connected. You might drop it down or it might cause damages to the connector part.
- Do not touch or hit the iPod terminal pins or the connector pins directly. It might cause damages to the connector part.
- If the iPod does not play correctly, please update your iPod software to the latest version. - For details about updating your iPod, check on the Apple web site <http://www.apple.com>.
- iPod is a trademark of Apple Inc., registered in the U.S. and other countries.
- iPhone is a trademark of Apple Inc.
- JVC is not responsible for any loss of or damage to iPod that might result from the use of this product.
- Sound distortion may occur when playing back audio sources with high recording levels. When distortion occurs, it is recommended to turn off the equalizer of the iPod. For information on operating the iPod, see the iPod instruction manual.
- If you do not turn on the power of this unit and only connect the iPod to this unit, power may be supplied to the iPod.
- "Made for iPod" means that an electronic accessory has been designed to connect specifically to iPod and has been certified by the developer to meet Apple performance standards.
- "Works with iPhone" means that an electronic accessory has been designed to connect specifically to iPhone and has been certified by the developer to meet Apple performance standards.
- Apple is not responsible for the operation of this device or its compliance with safety and regulatory standards.

5. Listening to FM Broadcasts

| Press | Functions |
|--------------|----------------------------------------------------------------------------------------------------------------------------------------------------------------------------------------------------------------------------------------------------------------------------------------------|
| FM MODE | Switch FM stereo/monaural. When there is too noisy in an FM stereo broadcast, you can reduce the static by switching to monaural reception. Press again to switch back to stereo reception. If the broadcast is not FM stereo, the sound becomes monaural, even if FM stereo is selected. |
| ▶ | Switch channel display / frequency display. Channel display is automatically switched to frequency display after approx. 10 seconds and will return to time display. |
| TUNER PRESET | Select a channel from P01 to P20. (The unit button can be used when channel display is selected.) |
| ▶▶ / ◀◀ | Change frequencies to tune in to FM radio station. (The unit button can be used when frequency display is selected.) Press and hold to search broadcast stations automatically. The search is finished when the signal is received. Press again while searching to quit search. |

Listening to FM radio

Stretch out the wire antenna located on the rear of the unit before using.

- 1 Turn the Unit power on.
- 2 Select "FM" with the SOURCE button.
- 3 Select a frequency with the ◀◀ / ▶▶ button.

NOTES

- Press and hold ◀◀ / ▶▶ button to search broadcast stations automatically. The search is finished when the signal is received. Press again while searching to quit search.
- When there is too noisy in an FM stereo broadcast, you can reduce the noise by switching to monaural reception. Press again to switch back to stereo reception.

Presetting Stations

- 1 Select "FM" with the SOURCE button.
- 2 Push the TUNER PRESET - + button to select the desired channel number (P01 to P20) to be registered.
- 3 While the desired channel number is displayed, press and hold the ▶|| button. → The channel number starts flashing.



- 4 While the channel number is flashing, use the ◀◀ / ▶▶ button to select the frequency (87.50 MHz) of the station that you wish to register.
- 5 Press the ▶|| button → The selected frequency will be registered.



- To confirm registration, push the TUNER PRESET - + to select the registered channel number (P01 to P20), and press ▶|| button to display frequency.

- 6 After presetting the station, you can easily select the channel with TUNER PRESET - +.

3

6. How to set the TIMER

Setting the alarm (ALARM-BUZZER)



- 1 Press the SET button to select "ALARM 1" or "ALARM 2". → The selected icon starts lighting.
- 2 Press and hold the SET button. → "ON" or "OFF" and starts flashing.
- 3 Use the DOWN/UP button to select "ON" and press the SET button. → starts lighting and the time display starts flashing.
- When "OFF" is selected, goes off and the alarm setting is disabled. The display returns to the current time.
- To separate "ALARM 1" and "ALARM 2", set to on/off for each.
- 4 While flashing, set each item with the DOWN/UP button.
- When the SET button is pressed, the flashing items will change in the following order.

Hour → Min. → TIMER PLAY time (10 to 30) → time display

- It is not necessary to set the "TIMER PLAY" time at this point.

- 5 Switch the ALARM switch to "BUZZER".
- of the set alarm starts lighting on the display.
- To check the set time, switch the display to alarm time (ALARM 1/ALARM 2) by pressing the SET button.
- The buzzer sounds for three minutes.
- If the set time of "ALARM1" laps over that of "ALARM2", the buzzer of the earlier set alarm stops when the latter one starts sounding.

Selecting iPod or FM radio for the alarm sound (ALARM-TIMER PLAY)

- 1 Set the alarm time.
- (See steps 1 to 4 of "To set the alarm (ALARM-BUZZER)")

Hour → Min. → TIMER PLAY time (10 to 30) → time display

- You can set the duration of time between timer-on and timer-off from 10 minutes to 30 minutes in TIMER PLAY time.
- If the power is off, turn the unit power on.
- Confirm that you can hear the iPod or FM radio.
- Set to an appropriate volume.
- 4 Switch the ALARM switch to "TIMER PLAY". of the set alarm starts lighting and the selected source is blinking on the display.

CAUTION:

- "AUDIO IN" cannot be selected as a source. Select another source.
- The "TIMER PLAY" does not work when the Unit power is turned off.

7. Playing back from other equipment

Connecting other equipment

Connect an external device to the AUDIO IN jack on the rear of the unit using a stereo mini plug cord (not supplied).

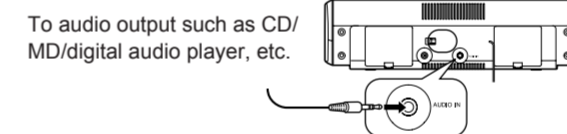

NOTE

- Always turn the power OFF when connecting or disconnecting other equipment.

8. Troubleshooting

If you are having a problem with your System, check this list for a possible solution before calling for service.

| In These Cases | Check the following points |
|--------------------------------------------------------------------------------------------------------|---------------------------------------------------------------------------------------------------------------------------------------------------------------------|
| Power does not come on. | AC adapter is not inserted securely. Plug in securely. The batteries are exhausted. |
| No longer works. | Press the RESET button (see "Resetting the unit" below). |
| Cannot set the iPod. | Is the Dock adapter properly mounted on the unit? Make sure to mount the Dock adapter properly. |
| Cannot operate iPod. | Is the iPod firmly connected to the connector plug of the unit? Is the iPod properly functioning? Test the iPod functions in stand alone condition. |
| iPod cannot be charged. | Is the iPod firmly connected to the connector plug of the unit? Is the AC adapter connected? The iPod cannot be charged while the Unit is operated on batteries. |
| Hard to listen to broadcasts because of noise. | The FM antenna is not properly extended and positioned. |
| When the volume level is manually set higher than "8", the unit automatically lowers the level to "8". | The unit's battery runs low (The "----" (Low battery) appears on the display). Replace the batteries with new ones. |

Resetting the unit

- "Troubleshooting" does not eliminate malfunctioning (failure to operate or display properly, etc.), press the RESET button on the rear of the unit with something having a sharp point, while the unit is turned on. After pressing RESET button, unplug the AC adapter and wait a while before plugging it again.
- When using RESET button, make sure the lithium coin battery is loaded.
- While resetting the unit, the clock is also reset. Adjust the clock after resetting the unit.

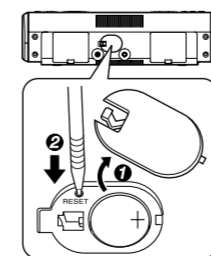

Stopping alarm sound

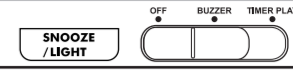

- To pause the alarm (snooze)
Press the SNOOZE/LIGHT button while the alarm is sounding, when the alarm is set with either "ALARM-BUZZER" or "ALARM-TIMER PLAY".
The alarm sound is temporarily stopped, and started again 5 minutes later. You can repeat this up to 10 times.

- To stop the alarm (BUZZER/ TIMER PLAY)

- Switch the ALARM switch to "OFF".

Deleting the alarm settings

- 1 Press the SET button to select the ALARM you want to delete.
- 2 Press and hold the SET button. → "ON" or "OFF" and starts flashing.
- 3 Use the DOWN/UP button to select "OFF" and press the SET button.
- The alarm setting is deleted.

To turn off the System after a certain period of time (Sleep Timer)

- 1 Press the SLEEP button repeatedly to specify the time (in minutes) as follows:

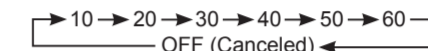

- 2 Wait until the set time goes off.

- To check the time remaining before the shut-off time, press SLEEP button once. If you press the button repeatedly, you can change the shut-off time.
- After the system is turned off with the Sleep Timer, you cannot operate any button other than the SNOOZE/LIGHT button. To operate the system as usual, press 0/1 to turn off the power and then turn on the power again.

NOTES

- Sleep Timer and "ALARM-TIMER PLAY" cannot be selected at the same time. If "TIMER PLAY" is selected, Sleep Timer will be cancelled.
- Sleep Timer and "ALARM-BUZZER" can be selected at the same time.

Listening to external devices

- 1 Turn the unit power on.
- 2 Select "AUDIO IN" with the SOURCE button.
- 3 Start playback on the external device.
- 4 Adjust the volume.

Changing batteries for the Clock

Be sure to match the poles (+/-) correctly.

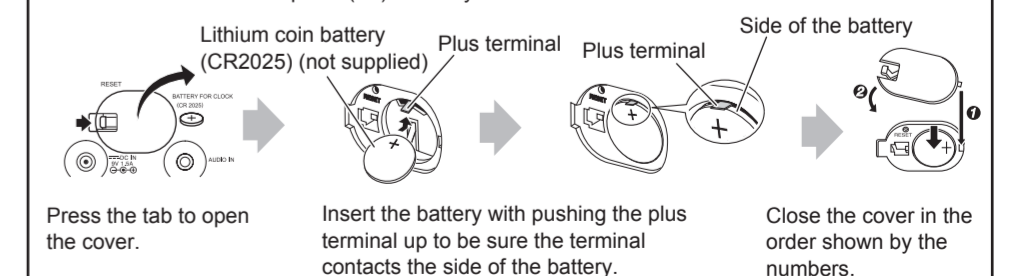

Time to change the battery

As the battery is running out, the display indication dims or the alarm may beep at the time the alarm is not set at. Replace the battery in such cases.